

C-U 10/50 HP W

DESCRIPTION

Sidewalls fitted longitudinally.

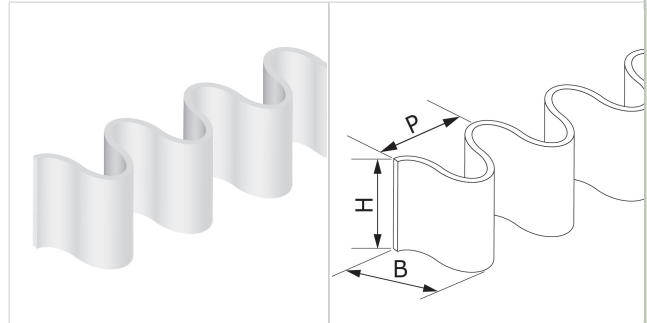

TECHNICAL SPECIFICATIONS

Material	Polyurethane (TPU) - HP® system		
Colour	White		
Hardness	85 ±5 Sh.A		
B = Base	22 mm	0,87 in.	
H = Height	50 mm	1,97 in.	
P = Pitch	24 mm	0,94 in.	
Thickness	1.7 mm	0,07 in.	
Weight	92 gr/m	0.082 oz/in.	
Minimum pulley diameters ⁽¹⁾			
■ longitudinal-conveying side	120 mm	4.7 in.	
⁽¹⁾ Minimum pulley diameters referred to environment conditions of 20°C			
Temperature resistance ⁽²⁾	min.	-30 °C	-22 °F
	max	70 °C	158 °F
⁽²⁾ Use with limit values may reduce its life			
Preformed or multiple roll length	20.0 m	65.6 ft	

COMPLIANCES

REACH EC 1907/2006 Regulation and Amendments
 EC 1935/2004 Regulation and Amendments
 EC 2023/2006 Regulation and Amendments
 EU 10/2011, 2023/1442 Regulation and Amendments
 HACCP (Hazard Analysis and Critical Control Points)
 FDA (Food and Drug Administration)
 HALAL (World Halal Authority)



METHOD OF APPLICATION

- High frequency welding

NOTES

Issue: 22-01-2020

Last Update: 22-01-2020

DISCLAIMER

The information contained in this document describes the features of the CHIORINO product as tested in a laboratory environment at a temperature of +23 degrees °C at 50% relative humidity. It does not necessarily reflect the conditions of industrial use and it does not guarantee the product to be suitable for certain applications. The client remains liable for the proper selection and correct use of the CHIORINO product. CHIORINO cannot be held responsible should damages arise from the use of its products. Necessary alterations to this data can be made without prior notice.