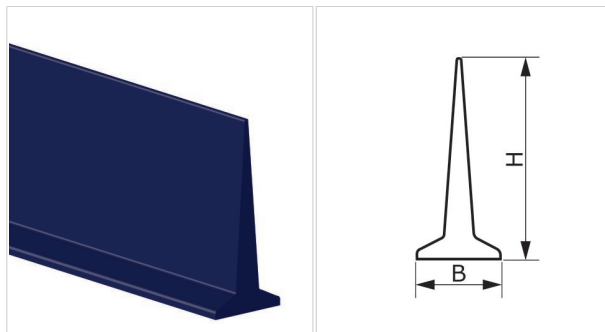

T30 U blue DET

DESCRIPTION

Polyurethane lateral profile, straight.

TECHNICAL SPECIFICATIONS

Material	Polyurethane (TPU)		
Hardness	85 ±5 Sh.A		
Colour	Dark blue		
Base	Flat		
B Upper base	10.0 mm	0.39	in.
b Bottom base	---	---	in.
H Height	30.0 mm	1.18	in.
Weight	130 gr/m	0.116	oz/in.
Minimum pitch			
■ longitudinal	---	---	in.
■ transversal	45 mm	1.8	in.
Minimum pulley diameters ⁽¹⁾			
■ longitudinal-driving side	---	---	in.
■ longitudinal-conveying side	---	---	in.
■ transversal-conveying side	60 mm	2.4	in.
⁽¹⁾ Minimum pulley diameters referred to environment conditions of 20°C			
Temperature resistance ⁽²⁾	min.	-20 °C	-4 °F
	max	70 °C	158 °F
⁽²⁾ Use with limit values may reduce its life			
Roll/bar sizes	2.4 m	7.9	ft

COMPLIANCES

REACH EC 1907/2006 Regulation and Amendments
 EC 1935/2004 Regulation and Amendments
 EC 2023/2006 Regulation and Amendments
 EU 10/2011, 2023/1442 Regulation and Amendments
 HACCP (Hazard Analysis and Critical Control Points)
 FDA (Food and Drug Administration)



METHOD OF APPLICATION

- High frequency welding

NOTES

PRODUCT CODE ES870

Last Update 11-02-2020

DISCLAIMER

The information contained in this document describes the features of the CHIORINO product as tested in a laboratory environment at a temperature of +23 degrees °C at 50% relative humidity. It does not necessarily reflect the conditions of industrial use and it does not guarantee the product to be suitable for certain applications. The client remains liable for the proper selection and correct use of the CHIORINO product. CHIORINO cannot be held responsible should damages arise from the use of its products. Necessary alterations to this data can be made without prior notice.